



中央研究院
資訊科學研究所

Institute of Information Science, Academia Sinica • Taipei, Taiwan, ROC

TR-IIS-11-004

An Integrated Network Mobility Management and Call Admission Control Scheme for Internet Access on High-speed Trains

Cheng-Wei Lee, Tsung-Yin Lee, Meng Chang Chen and Yeali S. Sun



July 27, 2011 || Technical Report No. TR-IIS-11-004

<http://www.iis.sinica.edu.tw/page/library/TechReport/tr2011/tr11.html>

An Integrated Network Mobility Management and Call Admission Control Scheme for Internet Access on High-speed Trains

Cheng-Wei Lee¹, Tsung-Yin Lee^{1,2}, Meng Chang Chen² and Yeali S. Sun¹

¹Dept. of Information Management, National Taiwan University, Taiwan

²Institute of Information Science, Academia Sinica, Taiwan

Abstract –Automotive telematics has become an important capability of high-speed rail systems, which are increasingly popular in the era of green technology. As train speeds increase, communications between devices on the train and devices outside the train encounter difficulties, and maintaining high quality communication is a major challenge. Moreover, handovers on high-speed trains occur more frequently, and have shorter permissible handling times. In this paper, the proposed 2MR scheme takes the advantage of the physical size of high-speed trains to deploy two mobile routers (MRs) in the first and final carriages. This scheme offers a protocol to allow the two MRs and wireless network infrastructure to cooperate in providing a seamless handover. The 2MR Call Admission Control (CAC) scheme gives integrated admission controls for applications of different priority classes. Our simulation results demonstrate that the 2MR scheme ensures QoS provisioning of admitted sessions, and reduces handover latency as well as packet loss for high-speed trains.

Index term: call admission control; high-speed train; network mobility; seamless handover

I. INTRODUCTION

Automotive telematics has become an important capability of modern vehicles, especially high-speed modes of transportation like high-speed rail systems, which are increasingly popular in the era of green technology. Other considerations, such as the weather, comfort and safety, make the high-speed train a popular choice for long distance journeys. This popularity has led to increased demand for high-speed rail system construction, besides its advances in speed. Existing commercial high-speed rail networks such as France's TGV system, Shanghai's Maglev Train,

and Taiwan's High Speed Rail, operate at speeds of 250~300 kilometers per hour (km/h). Several projects under construction in Europe, America and Asia will be capable of reaching 350 km/h and above. These speed improvements however, are clashing with similarly impressive achievements in smart mobile device technology, as customers accustomed to the near ubiquity of mobile Internet access also expect similar ease of use on long train rides. As train speeds increase, wireless communications between devices on the train and devices outside the train (called correspondent nodes, CN) encounter difficulties, and maintaining communication quality is a major challenge.

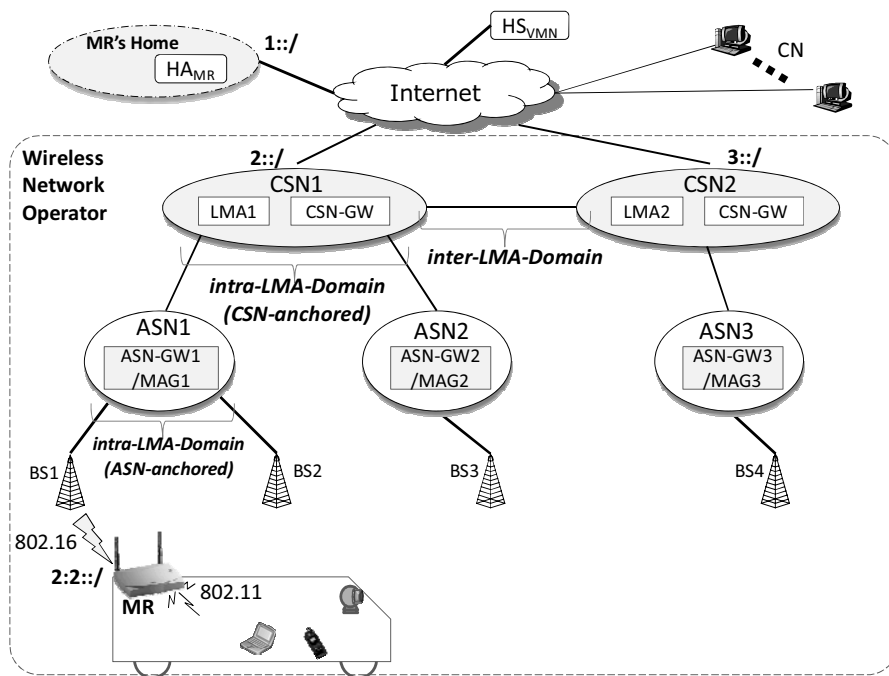

Fig. 1. An example of using Network Mobility under a WiMAX Wireless Network Operator.

Traditionally, each device connecting to the Internet on a train is treated independently of other devices, and thus signing in hundreds or thousands of devices to a base station (BS) simultaneously can be problematic. The wireless access technologies used on most end-devices do not support such rapidly moving environments, due to economic and technological considerations. As a result, various research efforts [1][2][3] have adopted the concept of *network mobility* to provide vehicle-to-infrastructure communications. Network mobility refers to the mobility of the network of devices within a *mobile network* that changes its point of attachment to

the Internet as one entity; all the data packets to and from the mobile network are transmitted via one or more designated mobile routers (MR) on the vehicle. The MR uses long-range wide-area wireless access technology, such as 3GPP Long Term Evolution advanced (LTE-Advanced) [4] or WiMAX 2 [5], to connect to wireless network infrastructure and the Internet. A mobile network contains two kinds of mobile network nodes (MNNs): local fixed and mobile nodes (LFMNs), and visiting mobile nodes (VMNs) [6], both of which use wired access technology like Ethernet or short range wireless access technology like IEEE 802.11n to connect to the MR (see Fig. 1). An LFMN is a vehicle equipped device that usually takes the form of a heat or pressure sensor, a camera, a train control and command system, or a public telephone. A VMN is a laptop computer or a smart phone carried by a passenger. The network mobility concept has a number of advantages in that it reduces the hardware and software system complexity and power consumption of MNNs, as well as the monetary cost involved in Internet access. Meanwhile, from the perspective of the network operator, it could reduce the processing and signaling overheads of Authentication, Authorization and Accounting (AAA) and network resource management.

Low quality train-to-infrastructure wireless links are not the only challenge in providing Internet access to MNNs on a high-speed train; the high speed of train also result in frequent handover events, within and across subnets. In addition, since the handover procedure can only be executed in the overlap area of adjacent BSs, the permissible handover time decreases as the train's speed increases. Efficient mobility management and handover protocols across BSs are required to ensure the continuity of real-time communication sessions (e.g., VoIP and video conference). In order to utilize the scarce wireless resources of the train-to-infrastructure wireless link efficiently, admission control and QoS requirement classification mechanisms must be applied to the MNN's communication traffic with different quality levels.

In this paper, we take advantage of the long physical size of high-speed trains and propose the 2MR scheme that deploys two MRs. We then design network mobility management in IPv6

network and handover protocols to provide seamless handover for the MNNs on the train. We also create a call admission control (CAC) scheme, including service class mapping, based on protocols and capacities in heterogeneous networks. Although we adopt the WiMAX terminology and technology for showcasing our design, the design could be applied to other high-speed wide-area wireless access technologies, such as LTE-Advanced with appropriate modifications.

The remainder of this paper is organized as follows. Section II reviews related work and background. Section III describes the architecture of the proposed 2MR scheme. In Section IV and V, the call admission control scheme and handover protocols are presented, respectively. We detail the simulation results in Section VI. Then, in Section VII, we conduct discussion and summarize our conclusions.

II. BACKGROUND AND RELATED WORK

A. Network Mobility

The Internet Engineering Task Force (IETF) network mobility basic support protocol [1] (called NEMO-bs hereafter) is a simple and effective method for managing global network mobility. By establishing a bi-directional tunnel between the home agent of the MR (HA_{MR}) and the MR, and maintaining the same Mobile Network Prefix (MNP_{con}) in the mobile network, NEMO-bs provides mobility transparency for the MNNs. There are proposed variants of NEMO-bs that provide route optimization by bypassing the HA_{MR} -MR tunnel [7][8] with additional components and functions. [2][9] are two other network layer protocols for route optimization that allow MNNs to use geographically meaningful IP addresses by using the visiting network prefix. Beyond focusing on the network layer, there are also solutions proposed for different protocol layers, such as HIP-based [10] and SIP-based [3][11] network mobility schemes.

For an LFMN, their communication targets, such as the train control center, are mostly located in the MR home network, and thus route optimization is not an issue for their traffic. In contrast, a VMN's communication targets are located in the Internet where route optimization is

critical for reducing end-to-end transmission delay and jitter. MR mobility management support for LFMNs and VMNs should be different. LFMNs rely on MR support, as they are designed to be simple. VMNs, however, use their terminal mobility management protocols, such as Mobile IP(v6), Dynamic DNS, SIP, or Skype, because VMNs are owned by the passengers and it is not likely for the MR to support all the protocols. Furthermore, for security reasons, it is better to isolate VMN and LFMN traffic to protect the communications between the train and its control center not interrupted by malicious VMN traffic.

A handover event is generally triggered by the detection of a change in BS, followed by the process of address reconfiguration and re-registration. The traditional mobility management systems discussed above are not sufficient for efficiently handling handover events, due to the short and frequent handover requirements of high-speed trains. Therefore, a new design to alleviate this problem is required.

B. Mobility Management in WiMAX

In this section, we review the terminology and technology of WiMAX. The network reference model proposed by WiMAX Forum [12] is shown in Fig. 1. The Access Service Network (ASN), which provides radio access to WiMAX subscribers, consists of one or more ASN Gateways (ASN-GWs) and base stations (BSs). The ASNs are connected by the Connectivity Service Network (CSN), which provides IP connectivity services. To support IP mobility, WiMAX Forum, 3GPP and 3GPP2 employ the Proxy Mobile IPv6 (PMIPv6) protocol [13]. The Localized Mobility Anchor (LMA) is located in the CSN and manages an LMA-Domain that owns a scope of network prefixes, and ASN-GW supports the Mobility Anchor Gateway (MAG) functionality. PMIPv6 supports the “per-MN-prefix model” and can be modified to support the “per-Mobile Network-prefix model” as well. That is, in the visiting network, the train’s mobile network is assigned a Mobile Network Prefix (MNP_{dyn} , e.g., 2:2::/ in Fig. 1) by the serving LMA (e.g., LMA1). The ASN-anchored handover and CSN-anchored handover are categorized as intra-LMA-Domain handover, in which there is no need to change

the MNP_{dyn} ; thus, it is not necessary for the subscriber to re-configure the address and re-register to its home server. Although this results in reduced handover delay and packet loss, there is still room for improvement by using the proposed 2MR scheme.

Because high-speed trains travel over a long distance, a Mobile Network Operator must deploy multiple CSNs with a number of LMAs to ensure scalability and fault tolerance. When a mobile network moves from one LMA-Domain to another (i.e., inter-LMA-Domain handover), it obtains a distinct MNP_{dyn} from a different LMA; then, the MNNs execute Layer-3 movement detection, address configuration and re-registration processes. Because these processes are time consuming however, the on-going handover sessions would suffer packet losses and may even be disrupted. For a high-speed train that has hundreds of on-going sessions, performing inter-LMA-Domain handovers frequently and simultaneously will worsen the problem.

C. QoS classes and parameters in WiMAX and WLAN

WiMAX supports five types of QoS for transmitting data [14]: Unsolicited Grant Service (UGS), real-time Polling Service (rtPS), non-real-time polling service (nrtPS), extended real-time Polling Service (ertPS), and best efforts service (BE). UGS supports real-time traffic with a constant bit rate (CBR) on a periodic basis, e.g., G.711 VoIP with CBR; ertPS supports real-time traffic with an on/off application on a periodic basis, e.g., VoIP with silent suppression; rtPS supports real-time traffic with a variable bit rate, e.g., video conferencing; nrtPS supports non-real-time traffic that requires a minimum reserved rate, e.g., FTP; and BE supports non-QoS guaranteed data, e.g., web browsing and e-mail.

The WLAN provides wireless Internet access to local hotspots, and is popular because of its affordability and availability. The WLAN based on the IEEE 802.11e standard [15] supports four access categories for transmitting data: Access Categories VoIP (AC_VO), Access Categories Video (AC_VI), Access Categories Best Effort (AC_BE), and Access Categories Background (AC_BK). AC_VO and AC_VI are used for real-time applications; and AC_BE and AC_BK are used for non-real-time applications. The different access categories have distinct priorities,

contention windows and transmission opportunities.

The integrated WiMAX and WLAN heterogeneous network generally maps the WLAN class of an application to a WiMAX class, and translates the WLAN QoS parameters to WiMAX performance parameters (and vice versa) to guarantee the application's QoS requirement. The QoS parameters in WLAN and WiMAX services are different. In the WLAN traffic specification, the minimum data rate, peak data rate and minimum service interval are used. An extra parameter, delay bound, is used for real-time applications. In the WiMAX service flow, the minimum reserve traffic rate, maximum sustained traffic rate and grant interval are used for both real-time and non-real-time applications, while an extra parameter of maximum latency is used for real-time applications. The class mapping between WLAN and WiMAX is in TABLE I.

TABLE I.
CLASS MAPPINGS BETWEEN WLAN AND WiMAX

Application	WLAN Access Category	WiMAX Service Class
VoIP with CBR	AC_VO	UGS
VoIP with silent suppression	AC_VI	ertPS
Video		rtPS
FTP	AC_BE	nrtPS
E-mail, HTTP	AC_BK	BE

III. THE PROPOSED 2MR SCHEME

A. Network Architecture and Components for High-speed Trains

Consider the high-speed train shown in Fig. 2. Two MRs are deployed, one in the head carriage and one in the tail carriage, denoted as MRh and MRt, respectively. Each MR has a WiMAX interface for train-to-infrastructure communication. Adopting multiple interfaces, the 2MR scheme increases the uplink capacity for an asymmetric wireless network, like WiMAX. In the local network, the VMNs and LFMNs are divided into two independent networks, called the VMN network and LFMN network, and both are managed in different ways (detailed in the next sub-section). The uplink traffic from both the local VMN and LFMN network is divided into two categories: ULh flows (e.g., nrtPS and BE) and ULt flows (e.g., UGS, ertPS and rtPS), which are

transmitted via the MRh and MRt, respectively. The downlink traffic (DL flows) is received by the MRt, to spare the MRh for initiating handover events.

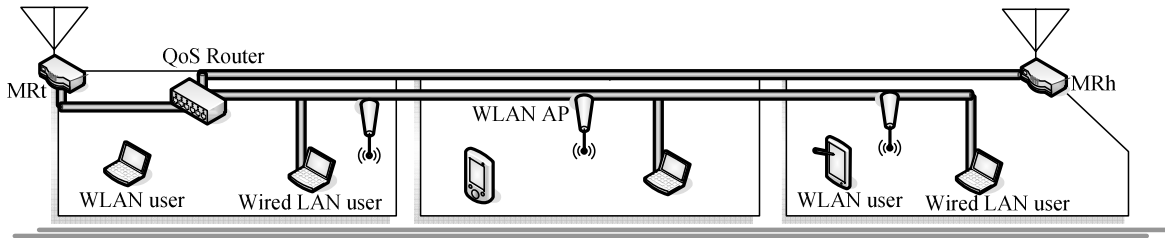

Fig. 2. 2MR Network Architecture in Train.

Since the length of a high-speed train is typically 200 to 400 meters, the MRh can connect with the target BS a few seconds earlier than the MRt. With proper coordination, the 2MR scheme can support seamless handovers for the DL/ULt flows by temporarily receiving/transmitting DL/ULt flows before the MRt connects with the target BS. As a result, the handover delays and packet losses are reduced with the cost of negligible packet forwarding delays between MRh and MRt.

The 2MR scheme does not modify the protocols and devices of WLAN. The QoS router is the default gateway of the VMN and LFMN network. When WLAN AP receives a new connection request, it forwards the request to the QoS router, and the QoS router maps the WLAN QoS requirement to WiMAX and transfers the request to the WiMAX BS via a MR. WiMAX BS will decide to admit or reject the connection request. The QoS router stores the QoS requirements and routing information of the admitted connection. The major functions of the QoS router are as follows:

- 1) *Train Information Database*: The database stores the information about all uplink/downlink connections and QoS requirements. The QoS router also records information about the train, including traveling path and speed.
- 2) *QoS Class Mapping Module*: Each application has its own QoS requirement, and the QoS Class Mapping Module transforms the QoS parameters between the WLAN and WiMAX.

3) *WLAN Call Admission Control Module*: When a new MNN requests to join the network, the module rejects the request if the WLAN cannot support the QoS requirements; otherwise, it forwards the request to a MR. The WLAN CAC Module also forwards the admission decision of WiMAX BS to MNN. We discuss the module in detail in Section IV. For simplicity, a BS refers to a WiMAX BS and an AP refers to a WLAN AP in the following sections.

B. IP Network Connectivity

To support the proposed 2MR scheme, several signaling messages are modified and the functionalities of the network components (e.g., BS, ASN-GW and LMA) in the infrastructure are altered. When the MRh and MRt on a train enter a new network, they set one of the bits in the Handover Supported Field in the 802.16 Registration Request (REG-REQ) message [14], and put related MRh and MRt information in the message to indicate the use of the 2MR scheme. The subsequent authentication and registration messages in the WiMAX network entry procedure deliver the information about the MRh and MRt to the BS, the ASN-GWs, and the servers in the CSN. On the completion of the network entry procedure, a MNP_{dyn} (e.g., 2:2::/ in Fig. 1) is assigned to the mobile network on the train. The MRh and MRt exchange the WiMAX and NEMO-bs registration information, such as the registration/authentication keys and the Care-of-Address (CoA), with each other by using a 2MR defined message, **2MRInfoExchange**.

In the 2MR scheme, LFMNs use MNP_{con} as their network prefix during the train journey, while VMNs use MNP_{dyn} , which was assigned in the visiting network and broadcasted by MRh using a Router Advertisement message. The VMN then configures a geographically meaningful address and registers with its own home server (HS_{VMN}). For example, a HS_{VMN} could be the home agent if Mobile IPv6 is used, or the REGISTRAR server if SIP is used. The VMN uses the address in subsequent communications with the CNs. The packets to/from the VMN will be transmitted by using the underlying Internet routing mechanism instead of via the HA_{MR} -MR tunnel.

IV. 2MR CALL ADMISSION CONTROL (CAC) SCHEME

The 2MR CAC scheme is built within the QoS router and BS to help these components cooperate together in system-wide admission control. Considering the protocols and performance models of WLAN and WiMAX separately, the CAC estimates their network throughputs and packet delays to make admission control decisions in order to guarantee the transmission quality of the integrated network. In this paper, we focus on using WLAN in the train local network; however, other access technologies, such as Ethernet or femtocell, can also be used to provide a variety of access service.

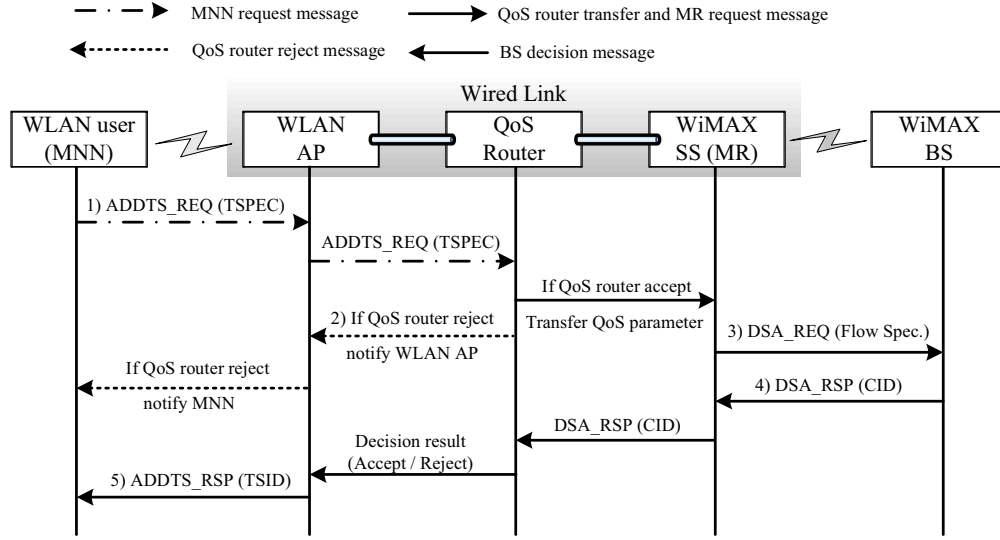

Fig. 3. Connection Establishment for MNN.

In Step 1 of Fig. 3, when an MNN issues a new connection request, it sends its TSPEC indicating the required access category, bandwidth and packet delay bound. The QoS router checks if the requested bandwidth and packet delay can be satisfied. In the 2MR CAC scheme, the WLAN throughput model is adopted from [16][17]. The minimum reserve rate for a connection k $Throughput_{min_reserve,k}$ in WLAN is bounded as follows:

$$\frac{PS_{mean,k}}{PD_{mean,k}} \geq Throughput_{min_reserve,k} \quad (1)$$

$$PD_{mean,k} = \frac{N_k}{\lambda_k (1 - P_{Nk})} \quad (2)$$

where $PS_{mean,k}$ is the average packet size for connection k ; $PD_{mean,k}$ defined in (2) is the mean

packet delay for connection k ; N_k is the average number of frames in the queuing system, P_{Nk} is the frame loss probability, and $\lambda_k (1 - P_{Nk})$ is the effective arrival rate of the traffic entering the transmission queue. The derivations of N_k , P_{Nk} and λ_k are adopted from [17]. The QoS router will reject the connection if its throughput requirement is not satisfied as shown in Step 2 of Fig. 3.

For real-time applications, the QoS router proceeds to check if the packet delay bound can be satisfied. The parameter $PD_{WLAN,k}^{X\%}$ is the boundary at $X\%$ packet delay time for WLAN connection k , defined as follows:

$$PD_{WLAN,k}^{X\%} = \beta T_{collision} + \gamma_k \sum_{h=0}^{\beta} \frac{W_{kh} - 1}{2} + T_{transmission} \quad (3)$$

$$\beta = \min(i \mid \sum_{j=0}^i p_k^j (1 - p_k) \geq X\%) \quad (4)$$

In (3), $T_{collision}$ is the average packet collision time ($T_{collision} = T_{DIFS} + T_{DATA} + T_{SIFS} + T_{ACK} + 2\delta$, where T_{DIFS} , T_{SIFS} and T_{ACK} are the time for DIFS, SIFS and ACK in the Distributed Coordination Function for 802.11, respectively, T_{DATA} is the average time of frame transmission and δ is the propagation delay). β defined in (4) is the minimum number of collisions when the ratio of successfully transmitted packets is higher than $X\%$ of total packets; p_k in (4) is the collision probability for admitted connection k that its derivation is adopted from [16][17]. γ_k is the average length of a time slot. $(W_{kh} - 1)/2$ is the average backoff time that W_{kh} is the value of the backoff counter at the h -th backoff stage, and lastly, $T_{transmission}$ is the average packet transmission time. If the packet delay bound and throughput are both satisfied, the QoS router translates the TSPEC to the WiMAX service class and performance parameters and then forwards the request through WiMAX SS using Dynamic Service Addition Request (DSA-REQ) to the BS as shown in Step 3 of Fig. 3.

For WiMAX, the 2MR CAC scheme follows a pre-specified bandwidth allocation policy such as priority-based or fixed bandwidth allocation policy to allocate bandwidth to different service classes. If a connection request arrives, 2MR CAC considers train movement and transmission quality to estimate the bandwidth and packet delay in order to admit or reject the connection

request. BS uses the SNR history data to calculate the mean (μ_{SNR}) and variance (α_{SNR}) of SNR for the past window period. With $W\%$ probability, the SNR in the next window period falls in the interval between $\mu_{SNR} \pm z_{W\%} \sqrt{\alpha_{SNR}}$, i.e., the tolerance interval [18] of the estimated SNR. The 2MR scheme defines the estimated SNR with $W\%$ probability as follows:

$$SNR_{WiMAX}^{W\%} = \begin{cases} \mu_{SNR} + z_{W\%} \sqrt{\alpha_{SNR}}, & \text{if } Current_{SNR} > \mu_{SNR} \\ \mu_{SNR} - z_{W\%} \sqrt{\alpha_{SNR}}, & \text{if } Current_{SNR} \leq \mu_{SNR} \end{cases} \quad (5)$$

Since the train moves along a fixed path, the SNR changes according to the relative direction and speed between BS and WiMAX SS. If the current SNR ($Current_{SNR}$) is larger than μ_{SNR} , the BS selects the upper bound of the tolerance interval as the estimated SNR for the next period. Otherwise, BS selects the lower bound. BS proceeds to check the modulation and coding scheme table [19] to calculate the transmission rate. Then, the BS calculates the available bandwidth by multiplying the available time slots and the transmission rate to decide if the request is admitted or rejected.

BS uses the transmission log of the service class that matches the connection request to estimate the mean ($\mu_{delay,k}$) and variance ($\alpha_{delay,k}$) of the packet delay. The packet delay with $Y\%$ tolerance is defined follows:

$$PD_{WiMAX,k}^{Y\%} = \mu_{delay,k} + z_{Y\%} \sqrt{\alpha_{delay,k}} \quad (6)$$

The BS sends the admission decision using the Dynamic Service Addition Response (DSA-RSP) message to the WiMAX SS as shown in Step 4 of Fig. 3. The WiMAX SS then forwards the decision with CID and QoS parameters to the QoS router and subsequently to AP. Finally, the AP notifies the WLAN MNN of the results, to end the CAC procedure as shown in Step 5 of Fig. 3.

V. 2MR HANDOVER PROTOCOLS

Under the 2MR scheme, in the normal state, the QoS router forwards ULh flows to the MRh and ULt flows to the MRt, while the MRt receives DL flows from the serving BS. During the handover period, this involves four steps:

- 1) The MRh initiates the handover procedure, and the serving BS negotiates with the target BS to reserve network resources for the DL and ULt/ULh flows.
- 2) The MRh disconnects from the serving BS, and the QoS router stops forwarding ULh flows to the MRh.
- 3) The MRh attaches to the target BS, and starts to receive the redirected DL flows. In the meantime, the QoS router forwards ULh flows to the MRt and ULt flows to the MRh.
- 4) The MRt attaches to the target BS, and starts to receive the DL flows. The QoS router returns to the normal state.

In the next two sub-sections, we describe the Intra-LMA-Domain and Inter-LMA-Domain handover protocols in the 2MR scheme.

A. Intra-LMA-Domain Handover

The Intra-LMA-Domain handover in WiMAX includes the ASN-anchored handover and CSN-anchored handover. The CSN-anchored handover consists of two phases: an ASN-anchored handover and an anchor ASN-GW relocation procedure. In the ASN-anchored handover, when the MRh reaches handover conditions, it makes a request to reserve the network resources for DL and ULt/ULh flows under the target BS. In WiMAX, a fully controlled handover includes the Preparation Phase and Action Phase [20]. The Preparation Phase starts with the MS Handover Request (MOB_MSHO-REQ) message sent from the MR to the serving BS. Then the serving BS sends HO_Req messages that eventually reach the candidate target BSs, which inform the anchor ASN-GW to check authentication and reserve network resources. Since the MRh has to reserve the required resources for itself and on behalf of the MRt, the MOB_MSHO-REQ, the HO_Req, and other messages in the Preparation Phase will carry the context of the MRh and the MRt, including the QoS requirements of the DL, ULh and ULt flows.

The signaling sequence of the Action Phase of the ASN-anchored handover under the 2MR scheme is shown in Fig. 4. In the second step, the MRh sends a Handover Indication (MOB_HO-IND) message to the serving BS to start the Action Phase. It also sends a 2MR

defined message, **2MRhHO**, to the QoS router, which will then stop forwarding ULh flows to the MRh. The **2MRhHO** message carries the MRh's WiMAX access parameters used to access the serving BS, such as the CIDs and keys, which will be used by the MRt to transmit the ULh flow. When the serving BS receives the **MOB_HO-IND** message, it sends a **HO_Cnf** message carrying the context needed for the MRh and MRt handover to the chosen target BS, to confirm that the MRh is about to attach to it.

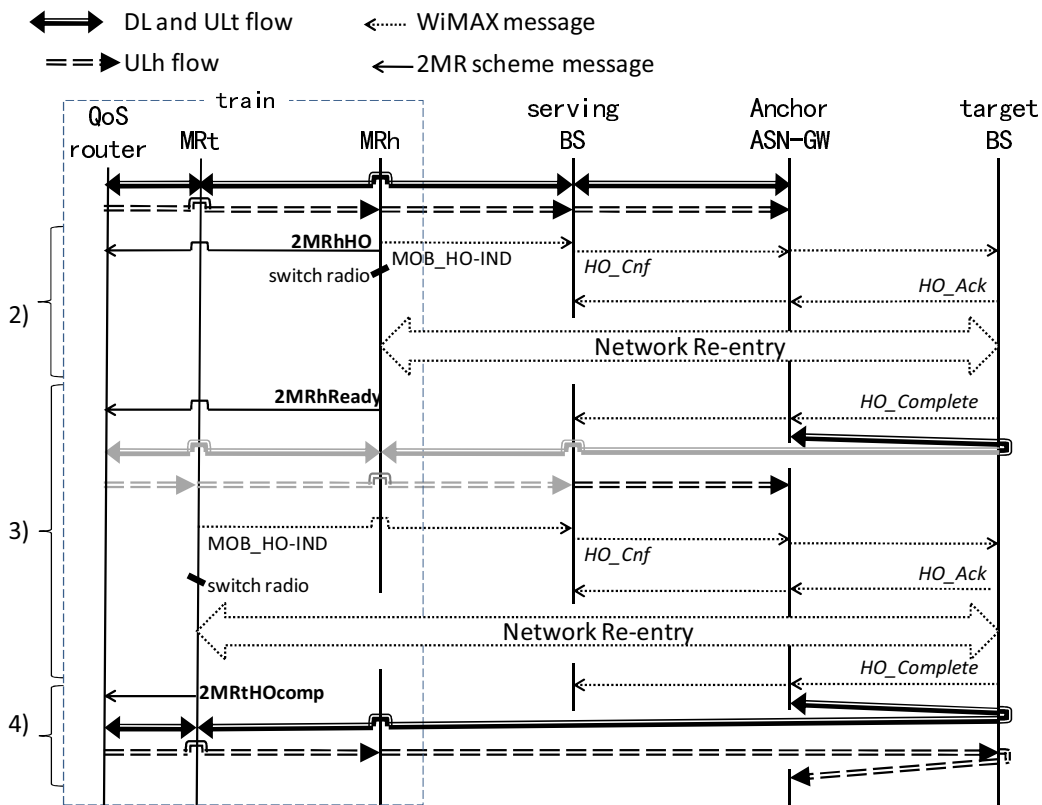

Fig. 4. The 2MR intra-LMA-Domain handover.

After negotiating new CIDs and connecting with the target BS, the MRh sends a 2MR defined message, **2MRhReady**, to inform the QoS router to start to forward ULt flows to the MRh, and to forward ULh flows to the MRt. At this moment, the MRh sends ULt flows to the target BS, and the MRt sends ULh flows to the serving BS. Meanwhile, the target BS sends the **HO_Complete** message to trigger the anchor ASN-GW to redirect the DL flows to the MRh via the target BS.

In step 4, when the MRt attaches to the target BS successfully, it sends a 2MR defined

message, **2MRtHOCmp**, to the QoS router and starts to receive DL flows using the WiMAX access parameters in the 2MRhReady. The QoS router returns to the normal state.

B. Inter-LMA-Domain Handover

The 2MR scheme supports Inter-LMA-Domain handover, which is not defined in the WiMAX standard. We consider a Mobile Network Operator that deploys multiple CSNs (i.e., multiple LMA-Domains). When the MRh is about to perform a handover to a target BS in another LMA-Domain with distinct MNP_{dyn} , we propose establishing a forwarding tunnel from the serving LMA to the target LMA for the DL flows to reduce handover delay and packet loss. Before the MRh attaches to the target BS, the network resources for the DL, ULh and ULt flows in the target LMA-Domain will be prepared by the target LMA and MAG. When attaching to the target BS, the MRh performs the WiMAX network entry procedure, including AAA procedure, and negotiates for new CIDs with the target BS. Before the MRh and VMN configure new IP addresses using the new MNP_{dyn} and re-register with their home servers and CNs, the on-going sessions can continue because of use of the LMA forwarding tunnel. We describe the procedures below.

In Fig. 5, the MRh prepares the handover by sending a MOB_MSHO-REQ that triggers the BS to send a HO_Req message to the anchor ASN-GW (i.e., the serving MAG). This MAG queries the topological database to determine that the handover is an inter-LMA-domain handover. In the 2MR scheme, the serving MAG sends a Proxy Binding Update (PBU) containing the contexts of the MRh and MRt, as well as information about the target MAG and the target LMA, to the serving LMA. Then, the serving LMA sends a 2MR defined message, **2MRHI**, with the contexts of the MRh and MRt to the target LMA. The LMA responds with a Proxy Binding Acknowledgement (PBA) to the serving MAG. At the end of the Preparation Phase, the serving BS sends a BS Handover Response (MOB_BSHO-RSP) message to the MRh to inform the MRh that it is ready for handover.

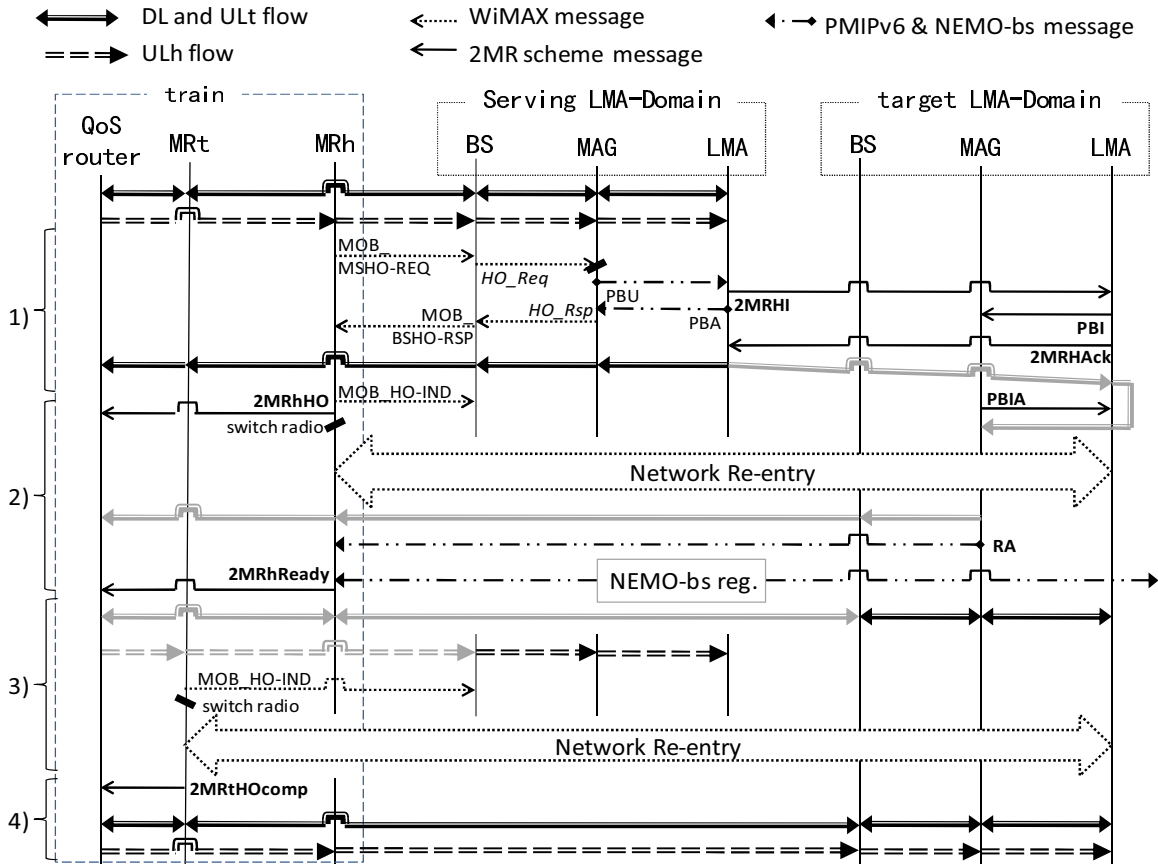

Fig. 5. The 2MR inter-LMA-Domain handover.

In the meantime, when the target LMA receives the 2MRHI message, it sends a 2MR defined message, **Proxy Binding Inform (PBI)**, with the contexts of the MRh and MRt (including the new MNP_{dyn} assigned by the target LMA) to the target MAG. It also replies with a 2MR defined message, **2MRHACK**, to the serving LMA. After receiving the 2MRHACK, the serving LMA will duplicate the DL flows to both the serving BS and the target LMA. When the target MAG receives the PBI, it responds with a 2MR defined message, **Proxy Binding Inform Acknowledgement (PBIA)**, to the target LMA. If the target LMA has received the PBIA from the target MAG, the packets forwarded by the serving LMA are then forwarded to the target MAG.

In steps 2 and 3, after the MRh sends MOB_HO-IND and attaches to the target BS, the target MAG starts forwarding the DL flows to the MRh, and sends a notification to the serving LMA to stop duplicating and forwarding packets to the serving BS. At this time, the QoS router

removes any duplicated packets it receives. After the QoS router receives the 2MRhReady message, it forwards ULt flows to the MRh. Meanwhile, after receiving the new MNP_{dyn} from the target LMA, the MRh configures two new CoAs for the MRt and itself, and re-registers them with the HA_{MR} . The MRh also provides the VMN network with the new MNP_{dyn} , so that the VMNs can configure the new IP address and re-register with their home server and the CNs, while continuing the on-going sessions. As the subsequent procedures are conceptually the same as Step 4 of Fig. 4 for intra-LMA-Domain handover, we do not repeat them here.

VI. PERFORMANCE EVALUATIONS

To evaluate the performance of the 2MR mobility management and CAC scheme, we conducted several simulations where we compared the performance of the 2MR scheme with alternative models, under various real-life conditions.

A. *The 2MR Handover Protocols Performance*

The environmental settings of the handover simulations are shown in Fig. 6. First, we use a train with length L (300 is used in the following simulations if not otherwise specified) meters and speed S km/h. The radius of a BS is 5 km, and the overlap of two adjacent cells is 400 meters. The transmission delay and processing overhead of each link, which are carefully selected to fit real-life conditions, is shown in Fig. 6. The performance of our 2MR scheme is compared with two other schemes: 1MR and 1MR-f. 1MR is the base case that deploys a single MR in the last carriage. 1MR-f has one MR with a forwarding tunnel between the serving BS and target BS established at the WiMAX Preparation Phase. In order to clearly demonstrate the handover effect between the different schemes, we use a 64 kbps CBR flow over UDP with a 10 ms packet interval sent from a CN. In the simulations, handover delay is defined as the time interval between the time that the train receives the last packet via the serving BS, and the time that it receives the next packet via the target BS.

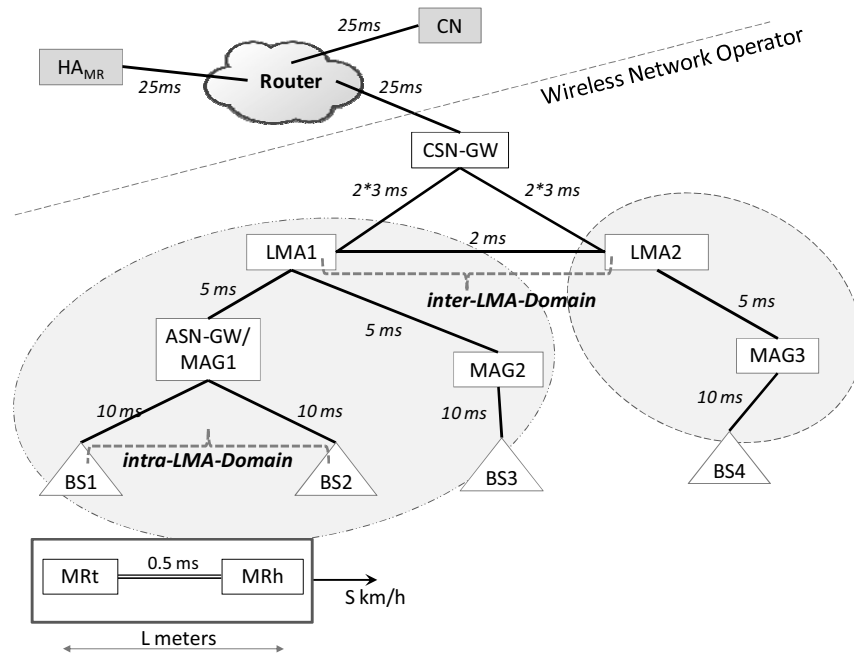

Fig. 6. The environment and the settings of handover simulations.

1) Intra-LMA-Domain Handover

First, the train moves from the coverage of BS1 towards BS2. Each case is run thirty times; the average handover delays of the 1MR, 1MR-f and 2MR schemes using different train speeds are shown in Fig. 7. When attached to the target BS, 1MR-f can receive forwarded packets immediately. In contrast, the 1MR scheme must wait for the target BS to tell the anchor ASN-GW to redirect the packet towards it, which incurs an extra 20 to 30 ms delay. In the 2MR scheme, before the MRt handover, the DL flow is redirected to the MRh via the target BS; the handover delay is contributed only by packet inter-arrival time and the link delay between the MRh and MRt.

The end-to-end transmission delay and packet sequence trace of speed of 450 km/h are illustrated in Fig. 8 and Fig. 9. Both the 1MR and 1MR-f schemes scan for candidate target BSs before handover. As a result, they cannot receive the DL flow from the serving BS, which explains the packet delay surges that occur before their handovers in Fig. 8. During handover, 1MR suffers from packet losses and 1MR-f experiences another packet delay surge, while 2MR has neither problem. From Fig. 9, the above phenomena can be observed from their packet

sequence traces. The transmission bursts of 1MR and 1MR-f indicate that the BS must allocate additional wireless bandwidth to the train, which may be difficult in a congested or low link quality network. Packet disorder can be observed for 1MR-f in Fig. 9. For 2MR, there is no packet loss, no burst transmission and no disordered packets observed, at the cost of negligible additional link delay from the MRh to the MRt.

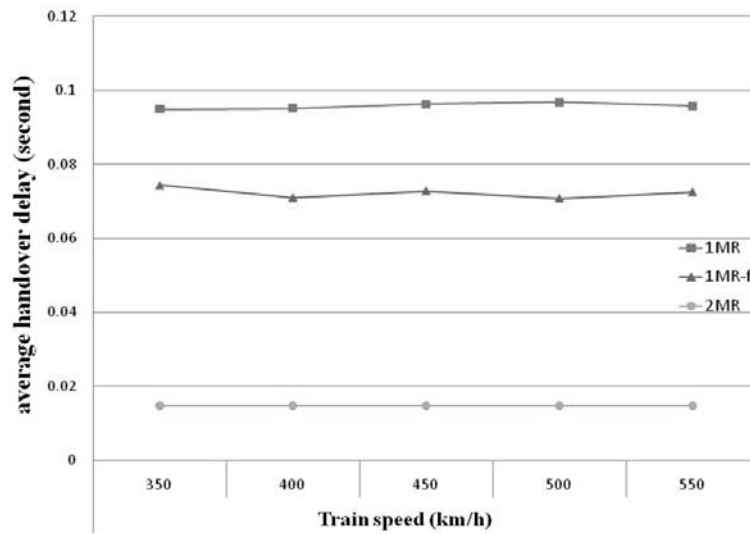

Fig. 7. Average handover delay of intra-LMA-Domain handover.

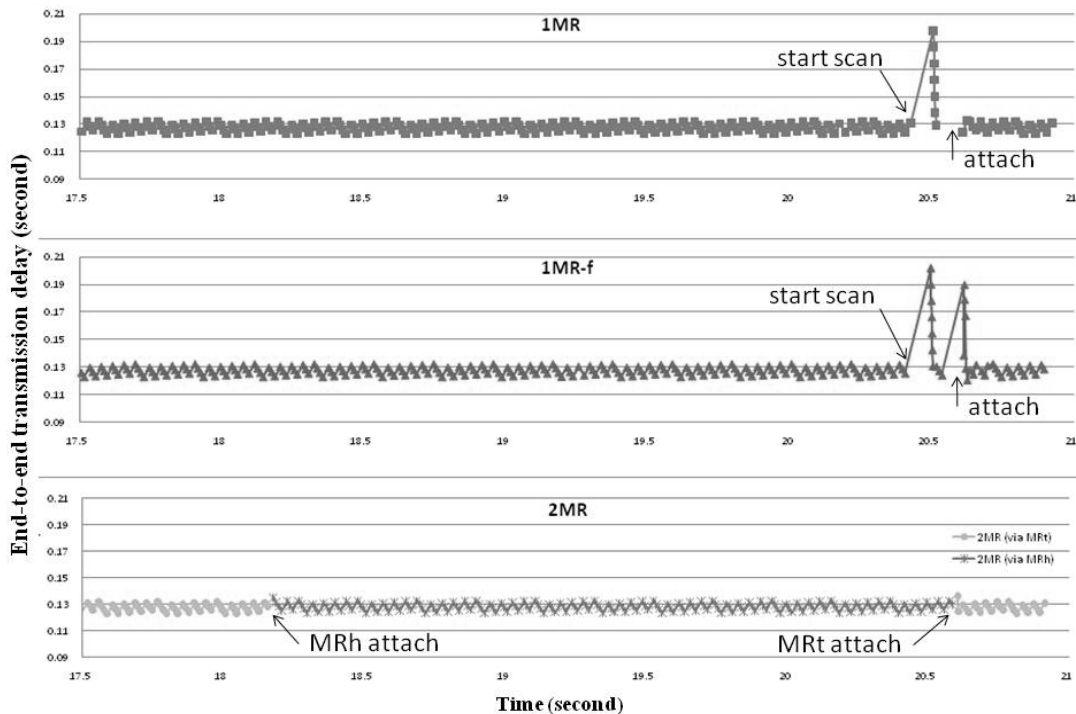

Fig. 8. The end-to-end transmission delay of intra-LMA-Domain handover.

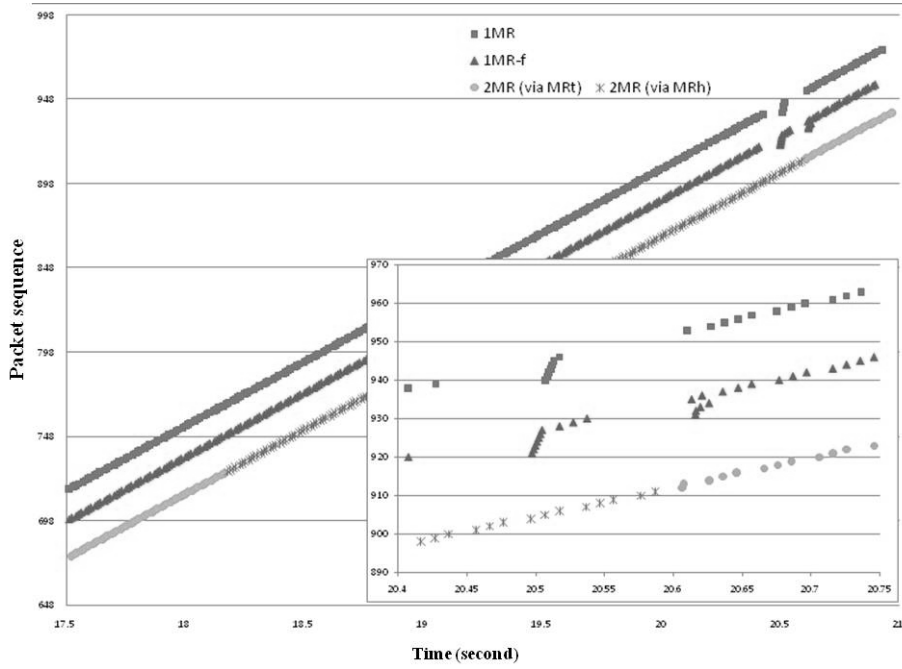

Fig. 9. The packet sequence trace of intra-LMA-Domain handover.

2) Inter-LMA-Domain Handover

Fig. 10 shows the average handover delays in 30 simulations of inter-LMA-Domain handover for 1MR, 1MR-f and 2MR when the train moves from BS3 to BS4. In Fig. 10, 1MR must complete the re-registration to the HA_{MR} before receiving the DL flow via the target BS, which results in a long (~240ms) handover delay. In contrast, the inter-LMA-Domain handover delays for 1MR-f and 2MR are similar to the intra-LMA-Domain handover, because both defer re-registration while using a forwarding tunnel to forward packets to the target BS. For the end-to-end transmission delay of the representative flow, Fig. 11 and Fig. 12 show similar delay curves and trends for 1MR, 1MR-f and 2MR when the speed is 450 km/h. Note that for 1MR-f, a forwarding tunnel can reduce handover delay, but adds extra end-to-end delay when packets are forwarded from the serving to the target BS, as observed in Fig. 11. For 2MR, there is a small delay surge at the MRh handover, which is also due to the tunnel forwarding delay.

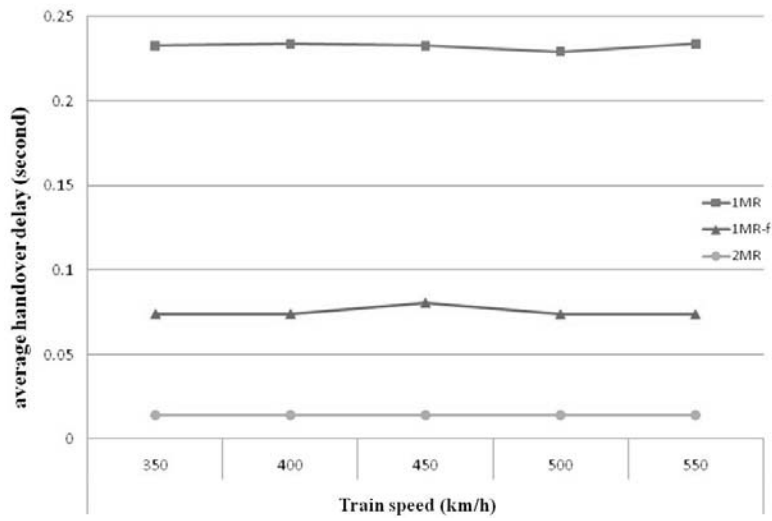

Fig. 10. Average handover delay of inter-LMA-Domain handover.

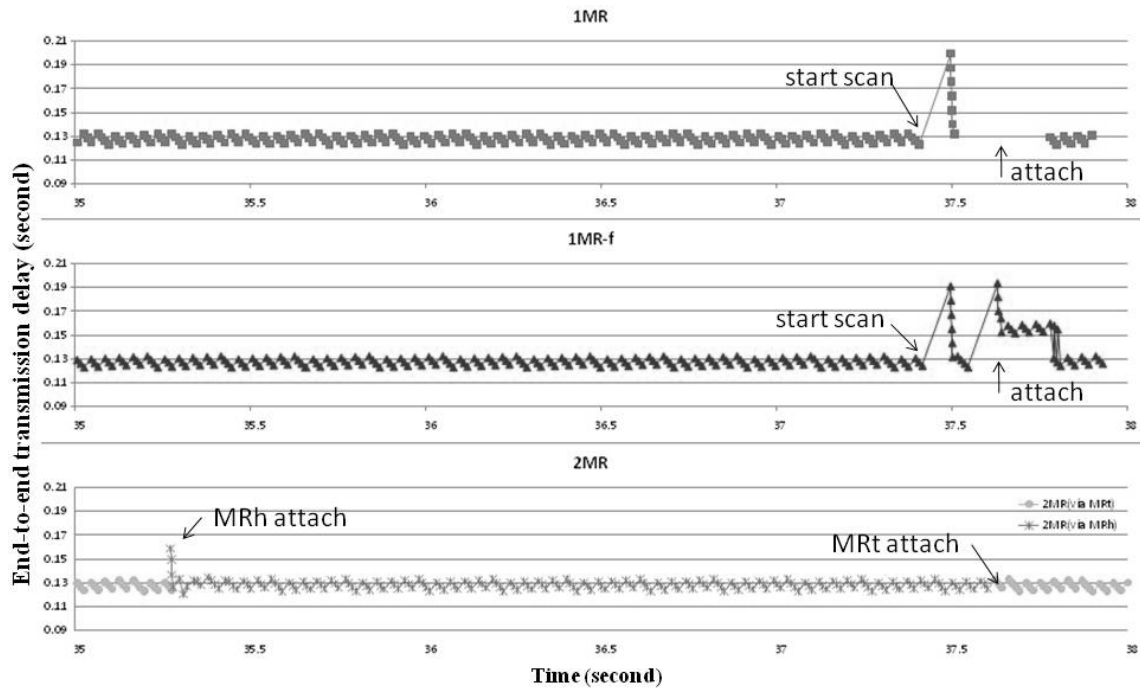

Fig. 11. The end-to-end transmission delay of inter-LMA-Domain handover.

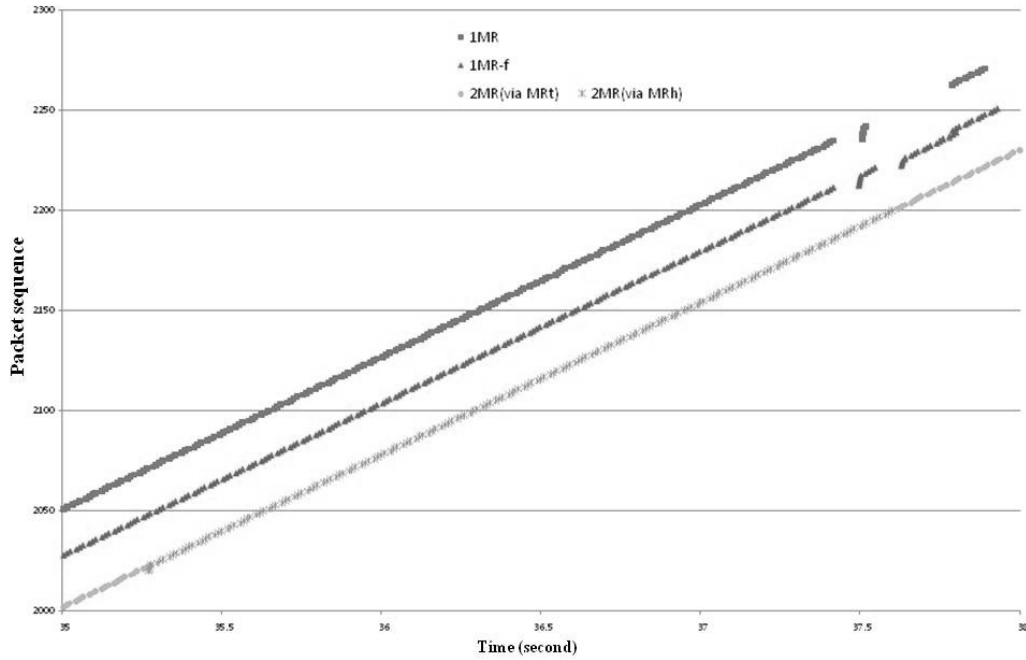

Fig. 12. The packet sequence trace of inter-LMA-Domain handover.

B. The CAC Scheme Performance

In this section, we examine the performance of 2MR CAC scheme. In the simulation environment, the QoS router is connected to four APs with different channels, two LANs and two SSs (i.e., the MRt and the MRh) on the train (see Fig. 2). There are two types of traffic in our scenario, namely G.711 VoIP and MPEG4 Video. The application QoS parameters are shown in TABLE II, and the detailed WiMAX and WLAN wireless network operation parameters are shown in TABLE III. The WiMAX BS reserves 10% of bandwidth for the best efforts applications and uses strict priority policy to allocate available bandwidth to other service classes.

TABLE II.
APPLICATION PARAMETERS IN CAC SIMULATION

		VoIP	Video
Traffic Description	Packet Size	Deterministic / 160 Bytes	Deterministic / 1285 Bytes
	Packet Interval	Deterministic / 20 ms	Exponential / 33 ms
QoS Requirement	Delay	50 ms	500 ms
	Throughput	64 Kb/s	304.128 Kb/s
Class Configuration	BS Polling Interval	20 ms	33 ms
	WLAN class	AC_VO	AC_VI
	WiMAX class	UGS	rtPS

TABLE III.
WIRELESS NETWORK PARAMETERS

(a) WiMAX Parameters

Parameters	Value
WiMAX system	OFDM / TDD
Central Frequency	2.4 Ghz
Channel Bandwidth	20 Mhz
Transmission Power	70 dBm
Modulation Scheme	BPSK ~ 64QAM
DCD/UCD Broadcast Interval	5 second
Request Backoff CW_{min}/CW_{max}	4 / 16
Frame Duration	5 ms
Scheduler	Strict Priority
WiMAX Antenna model	Omni-directional model
WiMAX Path Loss model	Two-Ray model
W%, Y%	99.9%, 95%

(b) WLAN Parameters

Parameters	Value
WLAN system	OFDM / EDCF (54 Mbps)
Beacon Interval	200 ms
Slot Time, SIFS, DIFS	9 us, 16 us, 34 us
AC_VO, AC_VI CW_{min}/CW_{max}	8 / 16
WLAN Antenna model	Omni-directional model
WLAN Path Loss model	Two-Ray model
X%	95%

In the simulation, the train speed is set to 450 km/h, and the total length of the rail line is 10 km. The BS is located at 300 meters away perpendicularly to the middle of rail, and the total simulation time is 80 seconds. Each WLAN and LAN has four admitted video sessions that continue during the simulation. We assume Poisson arrivals for VoIP sessions with mean of 10 VoIP sessions per second, with service time fixed for 10 seconds. A scheme named MSD is used for comparison that the BS uses the current measured SNR to calculate the available bandwidth and to determine if admitting the request or not. Another scheme named FIXED that it does not consider the change of SNR, i.e., it assumes a perfect transmission condition, used as the baseline scheme for comparison.

Fig. 13 shows the measured SNR scheme (denoted as MSD), and the 2MR scheme with 99.9% tolerance (denoted as 2MR). Before the 40th second, the train is nearing the BS with increasing SNR. The 2MR optimistically estimates a higher SNR than the measured SNR to admit more VoIP sessions. After the 40th second, the train moves away from the BS and the SNR decreases. The 2MR then becomes pessimistic and allocates less bandwidth to VoIP sessions.

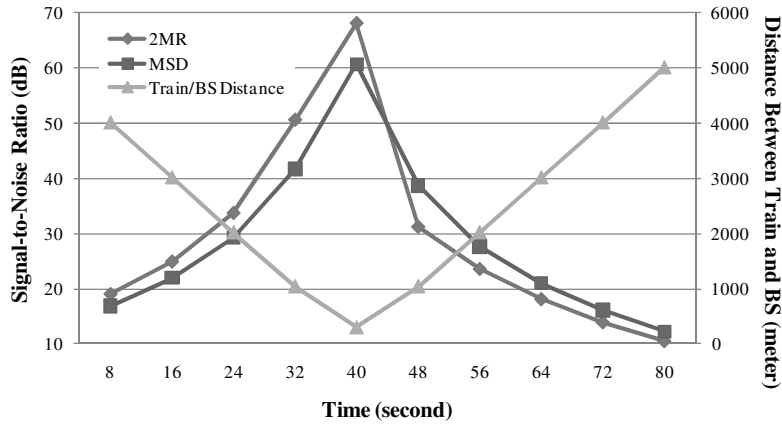

Fig. 13. SNR signal and Distance between train and BS.

Let the saturated throughput (THP_{sat}) be the capacity of the WiMAX wireless link in the simulation. Fig. 14 shows the blocking ratio and number of existing VoIP sessions. Before the 16th second, 2MR admits more VoIP sessions than MSD, so that it approaches the THP_{sat} earlier than MSD, utilizing the wireless link resources more efficiently. After the 64th second, the weak signal only supports a slow modulation scheme, decreasing THP_{sat} . The pessimistic nature of 2MR prevents over-admission by blocking more VoIP sessions than MSD. The FIXED scheme admits all VoIP connections for its over-optimistic nature.

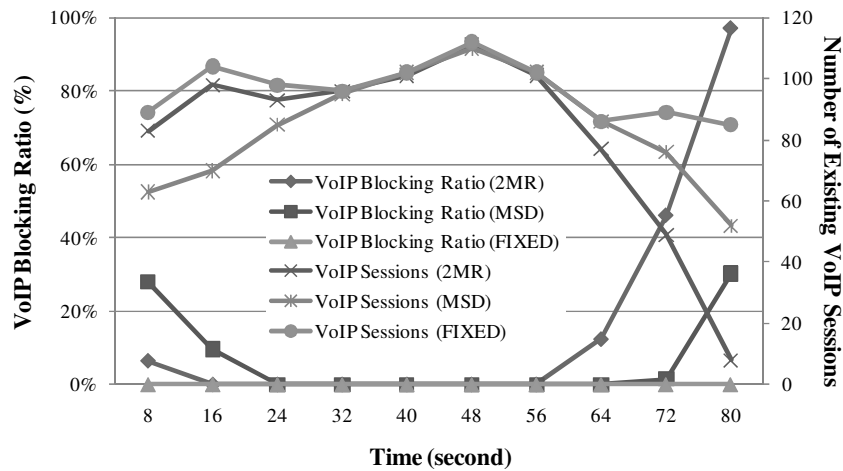

Fig. 14. VoIP Blocking Ratio and Number of Existing VoIP Sessions.

In Fig. 15, the QoS unsatisfied ratio of VoIP and video applications is illustrated. The QoS unsatisfied ratio is defined as the ratio of the packets violating delay or throughput requirements

to total packets. After the 64th second, the decreasing SNR spends more timeslots to transmit data, while MSD over-admits VoIP sessions, causing higher QoS unsatisfied ratio than 2MR. In Fig. 15, we also illustrate the goodput of VoIP and video applications. After the 72th second, the 2MR goodput is higher than MSD. The above results show that 2MR considers the train movement to provide higher quality transmission for real-time applications. The FIXED scheme suffers the highest QoS unsatisfied ratios. Fig. 16 shows the goodputs of all three schemes. The 2MR scheme performs the best, while the FIXED scheme is the poorest.

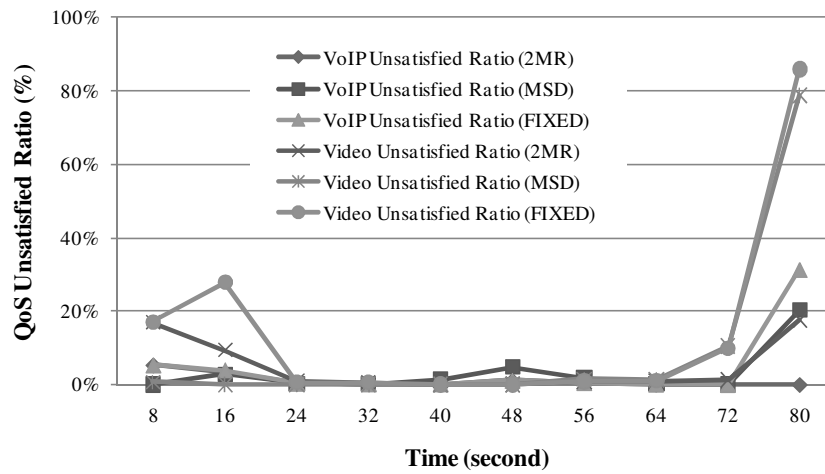

Fig. 15. QoS Unsatisfied Ratio.

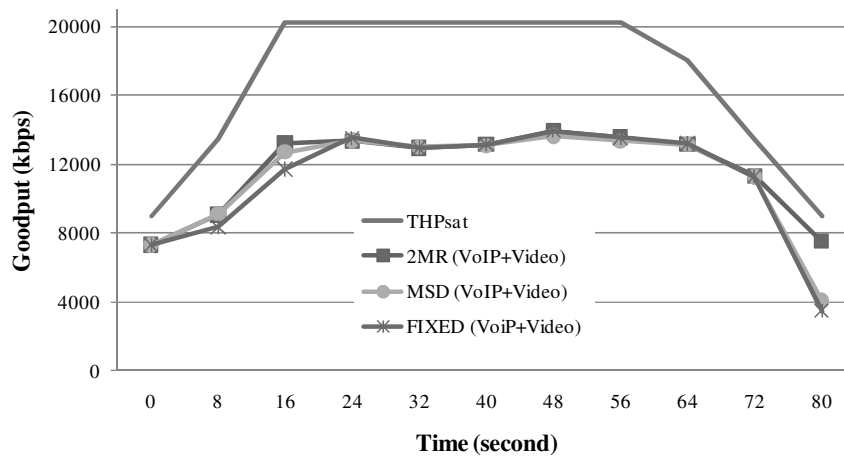

Fig. 16. Goodputs of 2MR, MSD and FIXED schemes.

VII. DISCUSSION AND CONCLUSION

Improvements in train speeds are bumping up against similarly impressive achievements in smart mobile device technology. Customers are increasingly desiring and expecting uninterrupted mobile Internet access, even on long train rides. Providing broadband wireless communication to high-speed trains relies on the precision of BS planning, which requires high monetary and manpower costs. The 2MR scheme effectively alleviates the problem of improper BS-planning, and is easy to deploy. By considering the protocols and capacities in both the train (local) network and the wide-area wireless access technology, and estimating the future train-to-infrastructure wireless link quality, the QoS provisioning of admitted sessions is ensured. In addition, by deploying two MRs at the first and last carriage, and designing new messages and functionalities in the PMIPv6-based infrastructure, the handover latency as well as packet loss is reduced while adding negligible extra data transmission delay.

Here, we discuss the permissible time for a seamless handover for 2MR scheme. We denote T_{ht} as the time interval from the time that the MR_h breaks down the wireless link with the serving BS to the time that the MR_t breaks the link down. Using 2MR handover protocol, if the MR_h completes the network entry and re-entry procedure within T_{ht} , the DL and UL flows can be handed over without disturbing the on-going sessions. In general, the MR_t uses the same handover threshold, such as signal strength, with the MR_h; therefore, T_{ht} can be derived by dividing the train's length (L) by its speed (S). For instance, for a train with length 300 meters and speed 360 km/h, T_{ht} is 3 seconds. In the event the network entry or re-entry procedure executed by the MR_h takes more time than L/S , a seamless handover becomes unlikely, unless the MR_t handover could be postponed, which implies a undesired, poorer transmission quality in the extended period.

REFERENCES

- [1] V. Devarapalli, R. Wakikawa, A. Petrescu and P. Thubert, "Network Mobility (NEMO) Basic Support Protocol," IETF RFC 3963, Jan. 2005.

- [2] M. Calderon, C. J. Bernardos, M. Bagnulo, Ignacio Soto, and Antonio de la Oliva, "Design and Experimental Evaluation of a Route Optimization Solution for NEMO," *IEEE J. Sel. Areas Commun.*, vol. 24, no. 9, pp. 1702-1716, Sep. 2006.
- [3] Y.-C. Tseng, J.-J. Chen, and Y.-L. Cheng, "Design and Implementation of a SIP-Based Mobile and Vehicular Wireless Network With Push Mechanism," *IEEE Trans. Veh. Technol.*, vol. 56, no. 6, pp. 3408-3420, Nov. 2007.
- [4] 3GPP - LTE-Advanced. [Online]. Available: <http://www.3gpp.org/article/lte-advanced>
- [5] WiMAX Forum. [Online]. Available: <http://www.wimaxforum.org>
- [6] T. Ernst, and H.-Y. Lach, "Network Mobility Support Terminology," IETF RFC 4885, Jul. 2007.
- [7] T. Ernst, "Network Mobility Support in IPv6," Ph.D Thesis, Department of Mathematics and Computer Science, Université Joseph Fourier, 2001.
- [8] F. Mimoune, F. Nait-Abdesselam, T. Taleb and Kazuo Hashimoto, "Route Optimization for Large Scale Network Mobility Assisted by BGP," in *Proc. IEEE GLOBECOM*, 2007, pp. 4659-4663.
- [9] H. Petander, E. Perera, K.-C. Lan and Aruna Seneviratne, "Measuring and Improving the Performance of Network Mobility Management in IPv6 Networks," *IEEE J. Sel. Areas Commun.*, vol. 24, no. 9, pp. 1671-1681, Sep. 2006.
- [10] S. Herborn, L. Haslett, R. Boreli and Aruna Seneviratne, "HarMoNy - HIP Mobile Networks," in *Proc. IEEE Veh. Technol. Conf.*, May 2006, vol. 2, pp. 871-875.
- [11] C.-M. Huang, C.-H. Lee, and J.-R. Zheng, "A Novel SIP-Based Route Optimization for Network Mobility," *IEEE J. Sel. Areas Commun.*, vol. 24, no. 9, pp. 1682-1691, Sep., 2006.
- [12] *Network Architecture - Stage 2: Architecture Tenets, Reference Model and Reference Points*, WMF-T32-001-R016v01, WiMAX Forum, 2010.
- [13] S. Gundavelli, K. Leung, V. Devarapalli, K. Chowdhury and B. Patil, "Proxy Mobile IPv6," IETF, RFC 5213, Aug. 2008.
- [14] *IEEE 802.16 Local and metropolitan area networks - Part 16: Air Interface for Broadband Wireless Access Systems (Revision of IEEE Std 802.16-2004)*, Standard, 802.16, May 2009.
- [15] *IEEE 802.11e Local and Metropolitan Area Networks - Specific Requirements Part 11: Wireless LAN Medium Access Control (MAC) and Physical Layer (PHY) Specifications Amendment 8: Medium Access Control (MAC) Quality of Service Enhancements*, Standard, 802.11e-2005, Nov. 2005.
- [16] G. Bianchi, "Performance Analysis of the IEEE 802.11 Distributed Coordination Function", *IEEE J. Sel. Areas Commun.*, vol. 18, no. 3, pp. 535-547, 2000.

- [17] H. Jia, G. Min, W. Jia and M. E. Woodward, "Admission Control in the IEEE 802.11e WLANs based on Analytical Modelling and Game Theory", in *Proc. IEEE GLOBECOM*, 2009, pp. 1-6.
- [18] A. M. Law, *Simulation Modeling & Analysis*, McGraw-Hill, 4th ed., 2007.
- [19] C. Hoymann, "Analysis and performance evaluation of the OFDM-based metropolitan area network IEEE 802.16," *Computer Networks*, vol. 49, no. 3, pp. 341-363, 2005.
- [20] *Network Architecture - Stage 3: Detailed Protocols and Procedure*, WMF-T33-001-R016v01, WiMAX Forum, 2010.